

T47 Series BB Installation Instructions



IMPORTANT NOTICE:

- Do not alter this product in any way as it can cause unseen damage. Any modifications to this product will void the warranty.
- TOKEN suggests taking your bottom bracket to your local authorized TOKEN dealer for installation, service and adjustments.
- Read the user's guide before installation and use. Follow all instructions carefully. If you have any questions, don't ride the bike. Take it to your local TOKEN dealer for assistance.

BEFORE RIDING:

- Check that there is no side-to-side movement in the bottom bracket. Also check that the cranks spin smoothly. If there is movement or the bottom bracket is not smooth, take the bicycle to your local TOKEN dealer for service or replacement.
- Ensure that the cranks are firmly attached to the bottom bracket. Improperly attached cranks can become detached from the bicycle and serious injury can result. Never ride a bicycle with improperly attached cranks.

AFTER RIDING:

- When cleaning the bottom bracket, only use mild soap and water. Never spray the bottom bracket with high-pressure water. Water can enter the bottom bracket and cause it to wear prematurely.

WARRANTY:

All TOKEN products are guaranteed against defects in materials or workmanship for two (2) years from the original date of purchase. This warranty applies to the original owner only and is not transferable. The warranty is considered void if resold. The warranty does not cover normal wear and tear or damage from abuse. Please see our website or contact your local dealer or distributor for more details.

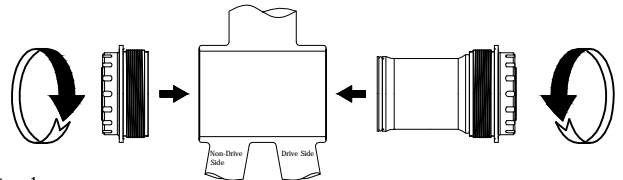

Step 1

Install any necessary spacer or adaptor, according to chart.

Step 2

Thread the cups into the frame using BB tool, ensuring they are tightened according to the direction arrows on the bottom bracket.

Step 3

Use a torque wrench to tighten to 35-50 N.m (310-443 in-lb)

www.tokenproducts.com

SHIMANO CRANKSET

MODEL: T47R24/T47R24-TBT

No.	Description	Q'ty
1	Right Cup	1
2	Left Cup	1
3	Sleeve	1
8	2.5mm Spacer	1

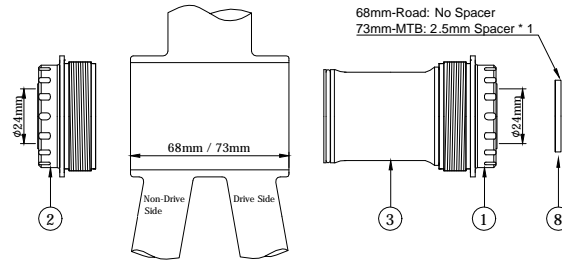

SRAM GXP CRANKSET

MODEL: T47RGXP/T47RGXP-TBT

No.	Description	Q'ty
1	Right Cup	1
2	Left Cup	1
3	Sleeve	1
4	GXP Adaptor	1
5	Wave Washer	1
6	0.6mm Spacer	1
8	2.5mm Spacer	1
9	1mm Inboard Spacer	2

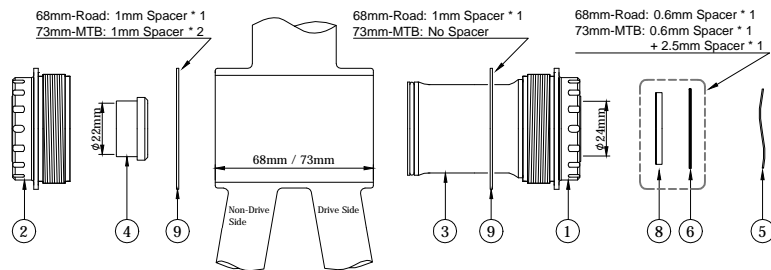

BB30 CRANKSET

MODEL: T47R30/T47R30-TBT

No.	Description	Q'ty
1	Right Cup	1
2	Left Cup	1
3	Sleeve	1
4	φ30mm Side Cover	2
5	Wave Washer	1

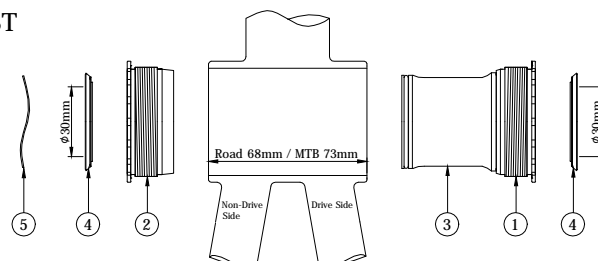

BB386 / BB392 CRANKSET

MODEL: T47R386/T47R386-TBT

No.	Description	Q'ty
1	Right Cup	1
2	Left Cup	1
3	Sleeve	1
4	φ30mm Side Cover	2
5	Wave Washer	1
6	0.6mm Spacer	3
7	2mm Spacer	2

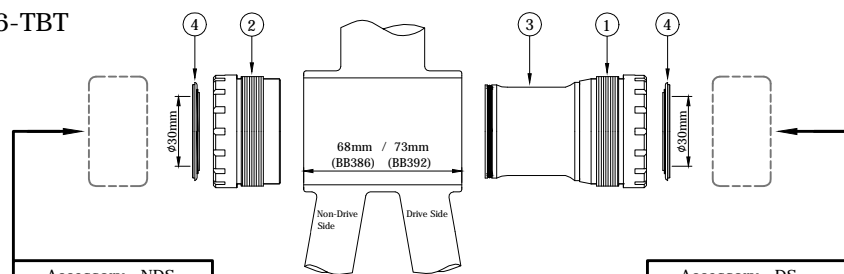

Accessory - NDS

BB386 Crankset (68mm frame)	FSA: (5) x1 ROTOR: (7) x1 EASTON (EC129): (6) x1 + (7) x1
BB392 Crankset (73mm frame)	FSA: (5) RF-Cinch (RF134): (7) x1

Accessory - DS

BB386 Crankset (68mm frame)	FSA: (x) ROTOR: (6) x2 EASTON (EC129): (6) x2 + (7) x1
BB392 Crankset (73mm frame)	FSA: (6) x2 + (7) x1 RF-Cinch (RF134): (6) x3 + (7) x1

T47 FRAME (M47 x 68mm / 73mm)

T47 FRAME (86.5mm / 92mm)
NOTICE - T47-Road (M47 x 85.5mm) Requires Two Additional Spacers

SHIMANO CRANKSET

MODEL: T47V24/T47V24-TBT

No.	Description	Q'ty
1	Right Cup	1
2	Left Cup	1
3	Sleeve	1
6	0.6mm Spacer	3

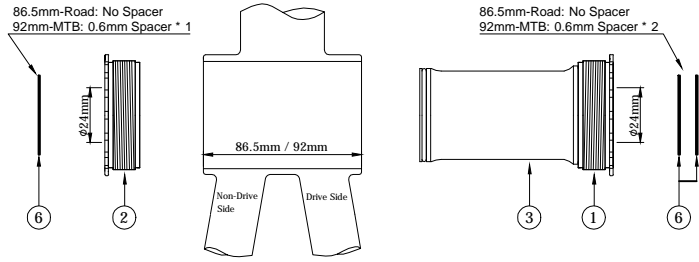

SRAM GXP CRANKSET

MODEL: T47VGXP/T47VGXP-TBT

No.	Description	Q'ty
1	Right Cup	1
2	Left Cup	1
3	Sleeve	1
4	GXP Adaptor	1
5	Wave Washer	1
8	2.5mm Spacer	1
9	1mm Inboard Spacer	2

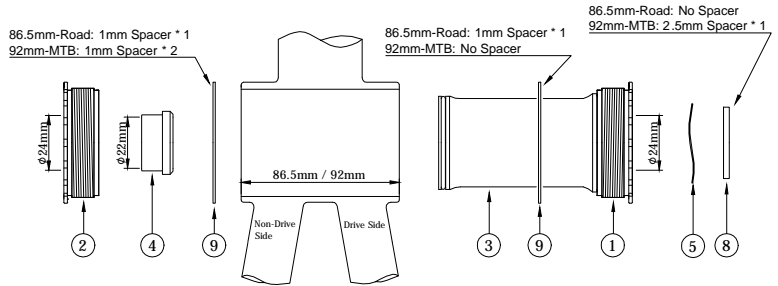

BB386 (FSA, ROTOR, EASTON) CRANKSET

MODEL: T47V386/T47V386-TBT

No.	Description	Q'ty
1	Right Cup	1
2	Left Cup	1
3	Sleeve	1
4	ø30mm Side Cover	2
5	Wave Washer	1
6	0.6mm Spacer	3
7	2mm Spacer	2

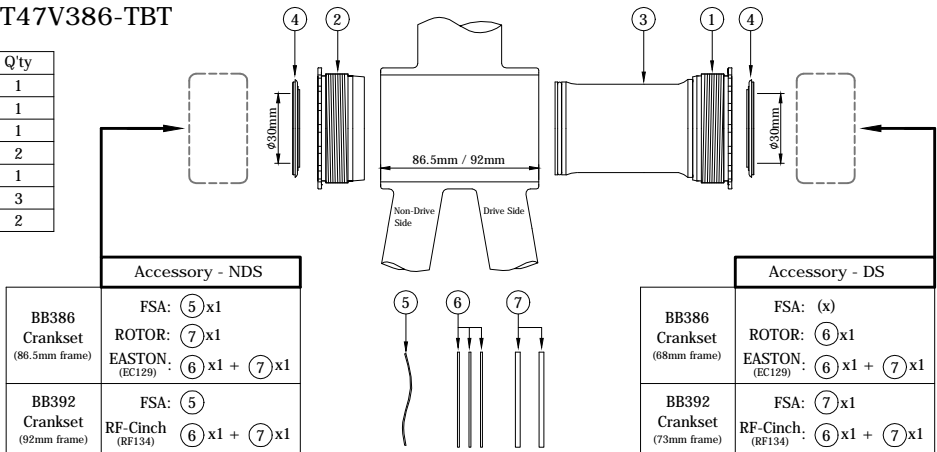

Spacers for T47x85.5mm Road Frames

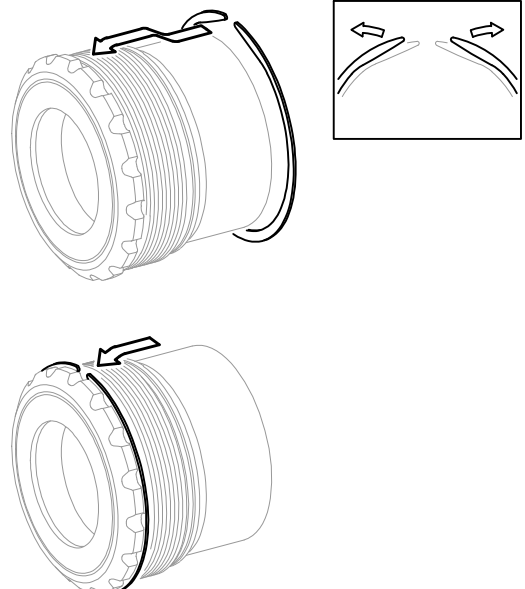
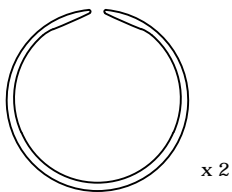

NOTICE

- The two additional 0.5mm-thick spacers are needed for T47x85.5mm Road frames. One spacer on each BB cup.

INSTRUCTION

- Gently open the two ends of the special spacer and snap it into the groove as shown in the diagram. Thread the BB cups into the frame (with other spacers when needed), and tighten them to specified torque.



WARNING

- Do NOT use the spacers on regular T47 (86.5mm or 92mm wide) frames - doing this will make the BB too wide, and the crankset cannot be installed correctly.